

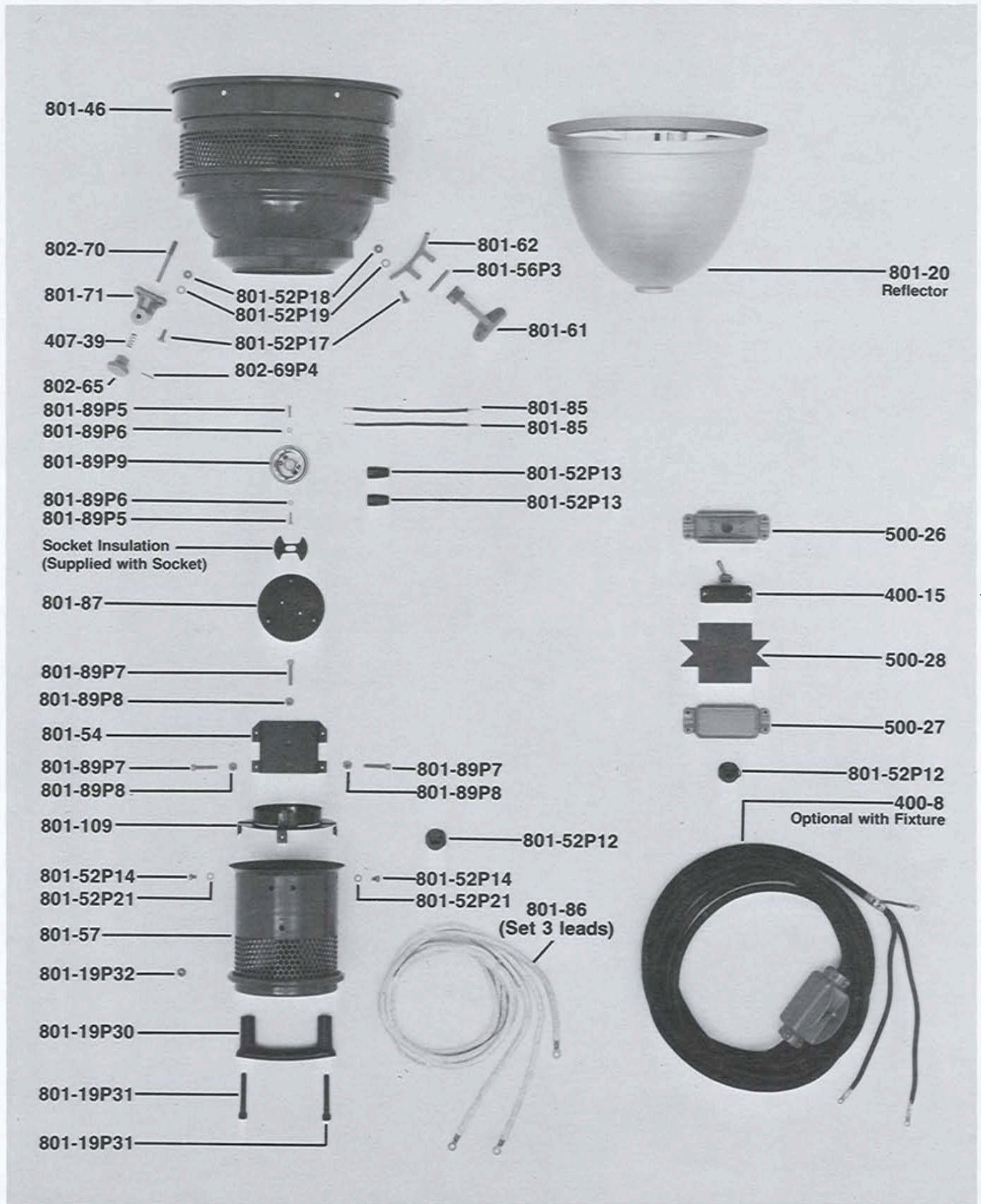

# PARTS FOR TYPE 8011 1,000 WATT MOLEQUARTZ® MOLELIPSO®

8011A9311



199



*Mole-Richardson Co.*



Tel. (323) 851-0111 Fax. (323) 851-5593 E-mail: info@mole.com Internet: http://www.mole.com 937 N. Sycamore Ave., Hollywood, California 90038-2384 U.S.A.

©Mole-Richardson Co., Hollywood, California U.S.A.



# PARTS FOR TYPE 8011

## 1,000 WATT MOLEQUARTZ® MOLELIPSO®

8011B9311

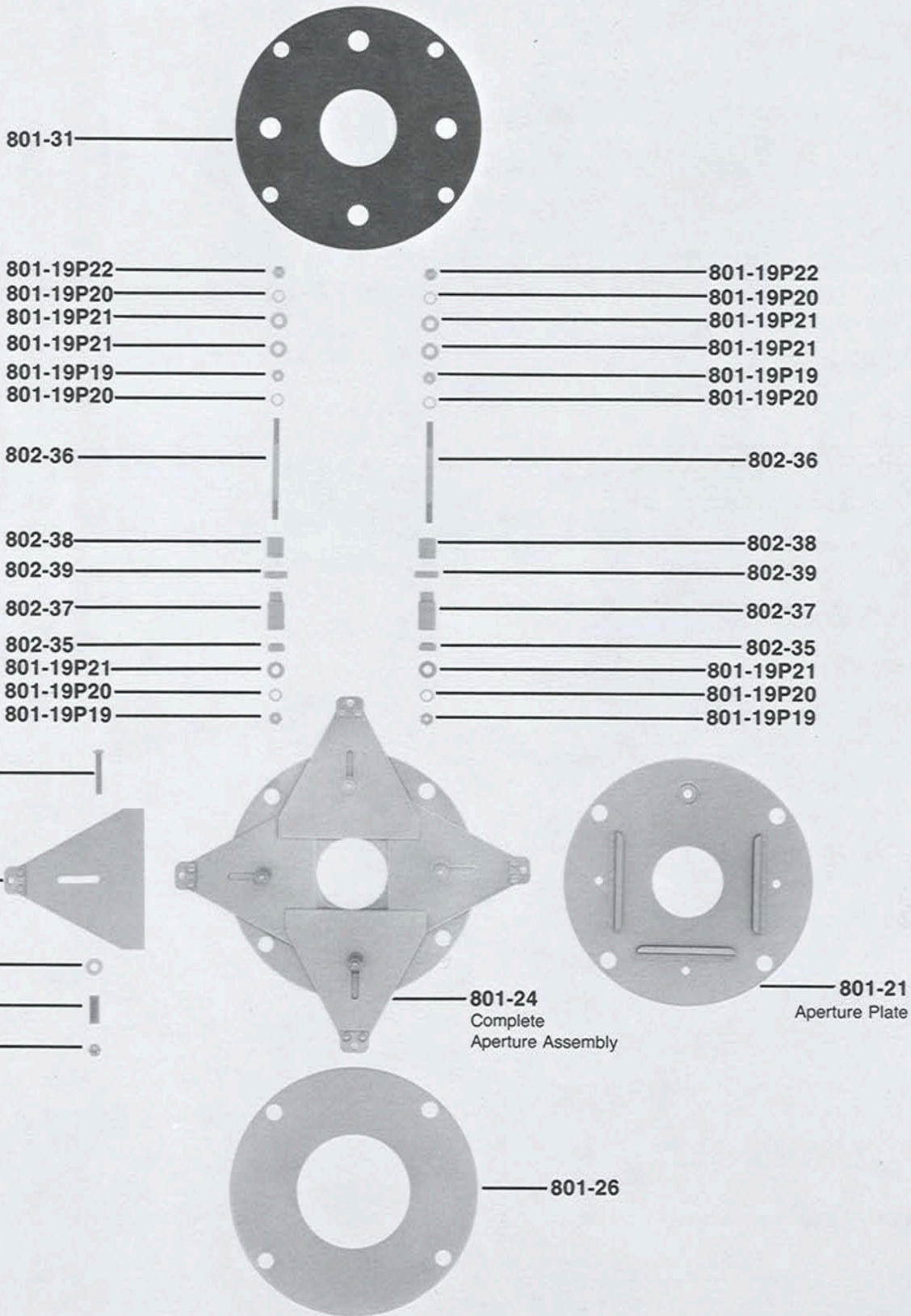

*Mole-Richardson Co.*







# PARTS FOR TYPE 8011 1,000 WATT MOLEQUARTZ® MOLELIPSO®

8011C9311

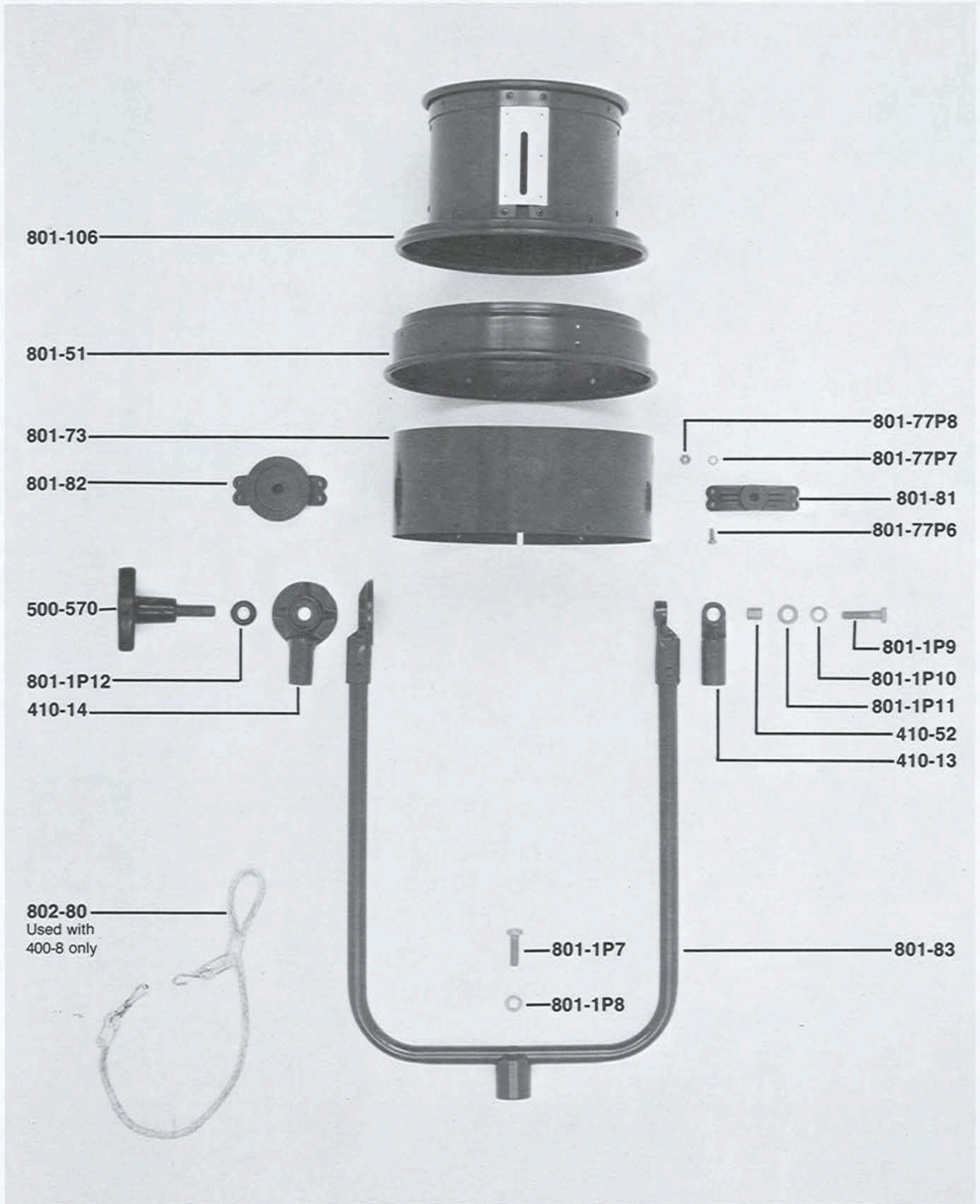

201



*Mole-Richardson Co.*





# PARTS FOR TYPE 8014 AND 8016 ACCESSORY LENS ASSEMBLIES

8011D9311

## TYPE 8014

## TYPE 8016

801-94

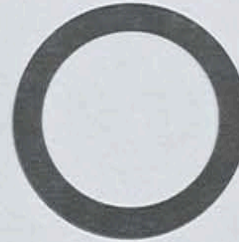

801-93

801-17

4½" x 9" Lens



802-16

6" x 12" Lens

801-104

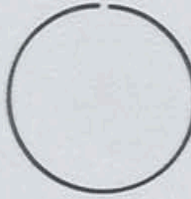
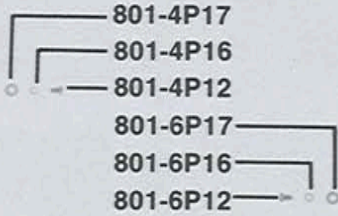

802-104

801-104

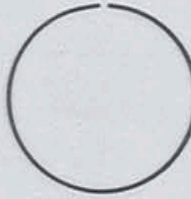

802-104

801-17

4½" x 9" Lens



802-16

6" x 12" Lens

801-104



802-119

801-4P15



802-119

801-6P15

801-4P14

801-4P13

802-95

802-95

802-95



801-224



802-67



802-95

801-6P14

801-6P13

802-95

802-95



801-224

802-67



202



*Mole-Richardson Co.*







# PARTS FOR TYPE 8012 AND 80112 ACCESSORY IRIS ASSEMBLIES

8011E9311

## TYPE 8012

## TYPE 80112

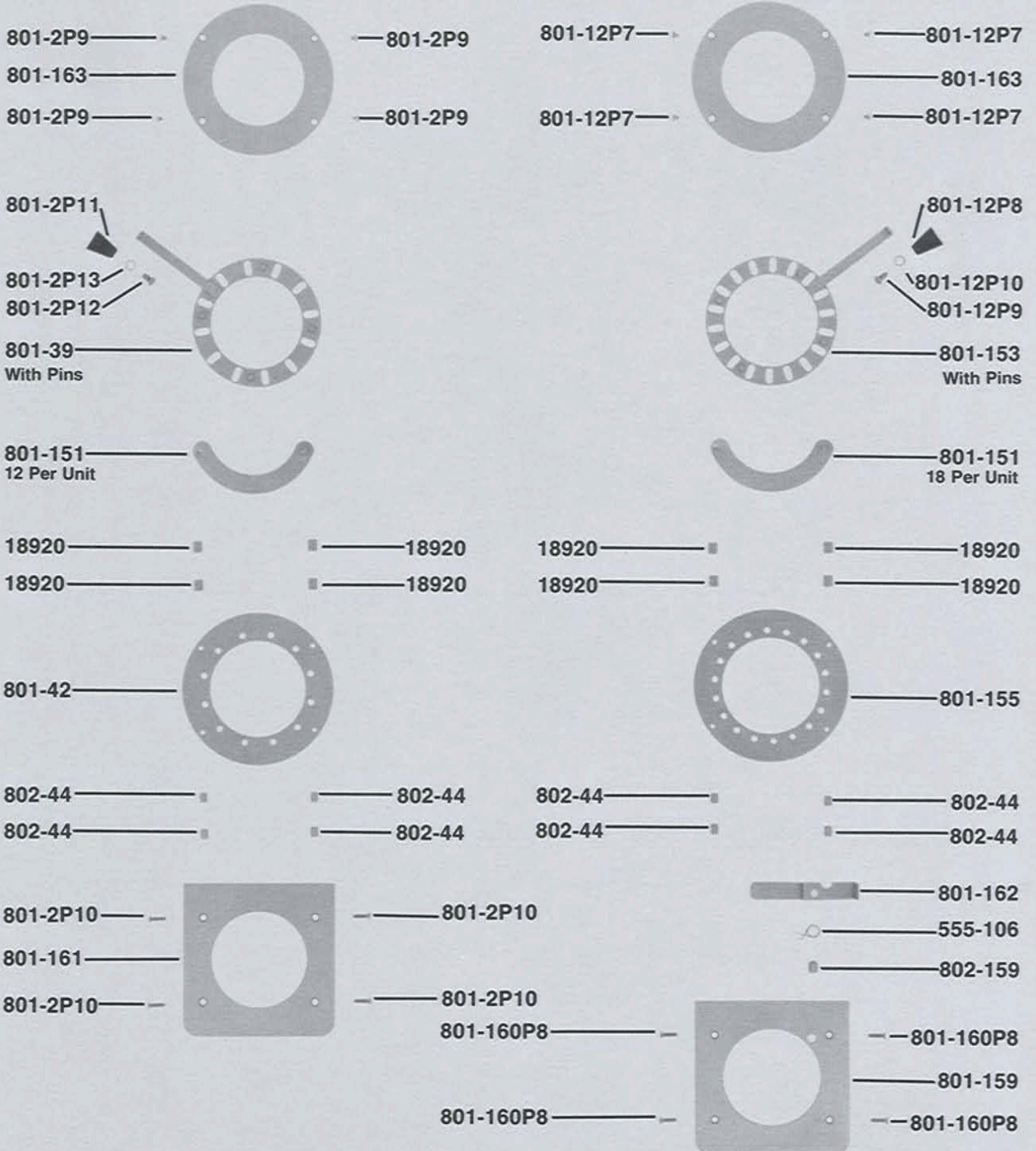

203



*Mole-Richardson Co.*

